

# FQ55FNDF



Product Family	Refrigerator
Installation	Free standing
Category	2 Doors & 2 Drawers
Reference width	Higher than 80
Sistema Total No - Frost	Total
Cooling type	Fan assisted refrigerator, no-frost freezer
Defrost	Automatic
Hinge type	Standard
EAN code	8017709293284



## Aesthetics



Aesthetic	Universale	Side material	Steel
Colour	Black	Side colour	Black
Finishing	Glossy	Logo	Applied
Design	Flat	Door shelves profile color	Silver
Material	Metal sheet	Drawers profile color	Silver
Handle	External	Color of glass shelf profile	Silver
Handle type	Fixed	Display	LED
Handle colour	Black	Display position	Esterno (su porta)
Logo colour	Chrome		

## Refrigerator compartment features



No. of adjustable shelves	3	Crisper Cover	Yes
Number of fruit and vegetables drawers	2	Type of crisper/vegetable drawers cover	Glass
Type of adjustable shelves	Glass	Internal light in fridge	Yes
Type of crisper/vegetable drawers cover	On sliding rails	Type of internal light (fridge)	LED

## Refrigerator Inner Door

No. of door shelves with transparent cover 2

Number of adjustable door shelves 4

Adjustable door shelves with wire support Yes

No. of bottle shelves 2

Bottle shelves with wire support Yes

## Other Refrigerator features



Accessories Egg tray

Natural Plus Blu Light Yes

MultiFlow Yes

Fan Yes

Ionizer Yes

Antibacterial odour filter Yes

## Freezer compartment features

Number of drawers 2

## Other Freezer features



Accessories 1 ice box

Fast freezing compartment Yes

## Other technical features

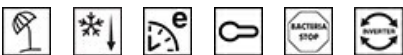

Functions display Holiday, Fast freezing, Fast cooling, ECO, Control lock

Fast freezing button Yes

Door open alarm Yes

Temperature Alarm Yes

Antibacterial Gasket Yes

Type of temperature control Electronic

No. of compressors 1

Refrigerant gas type R600a

Type of compressor Inverter

Refrigerant Quantity (gr) 63 g

Foam agent Cyclopentane

## Performance / Energy Label NEW 2019



Annual energy consumption 378 kWh/a

Airborne acoustical noise emissions 35 dB(A) re 1pW







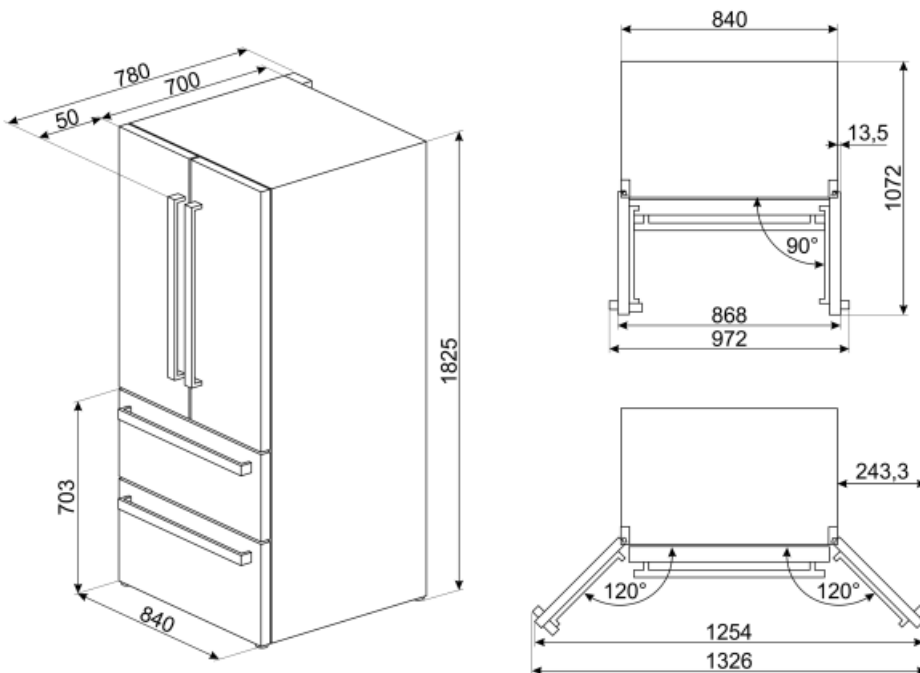









<b>Energy efficiency class</b>	F	<b>Temperature Rise Time</b>	18 h
<b>Airborne acoustical noise emission class</b>	B	<b>4 star - Freezing capacity</b>	10.7 Kg/24h
<b>Total net volume</b>	539 l	<b>Climate class</b>	SN, ST
<b>Sum of the volumes of the frozen compartment(s)</b>	152 l	<b>EI</b>	125 %
<b>Sum of the volumes of the chill compartment(s) and the unfrozen compartment(s)</b>	387 l		

## Electrical Connection

<b>Plug</b>	(F;E) Schuko	<b>Voltage (V)</b>	230 V
<b>Electrical connection rating</b>	160 W	<b>Frequency (Hz)</b>	50 Hz
<b>Current</b>	0.9 A	<b>Power supply cable length</b>	240 cm



## Symbols glossary (TT)

 <p>4 stars freezing compartment for better food preservation.</p>	 <p>Smeg Active Ion system improves the quality of the air inside the cell. Thanks to the generation of negatively charged ions released inside the fridge Active Ion system neutralizes unpleasant dust.</p>
 <p>The automatic defrost system works by automatically defrosting at regular intervals eliminating the need to defrost altogether.</p>	 <p>Antibacterial treatment: antibacterial treatment to ensure better hygiene</p>
 <p>Child lock: some models are fitted with a device to lock the programme/cycle so it cannot be accidentally changed.</p>	 <p>LED display: to show programmes, functions and options selected and the time to the end of the cycle.</p>
 <p>Economical mode: Analyzes fridge functioning during the activation and optimizes the operating cycle in order to reduce power consumption.</p>	 <p>Energy efficiency class F</p>
 <p>A++: Energy efficiency class A++ helps to save up to 20% energy compared to class A. Maximum performance with minimum consumption is guaranteed.</p>	 <p>Ventilated: Forced distribution of cold air in the refrigerator compartment, which allows even temperature distribution within the fridge.</p>
 <p>Fast freezing: The fast freezing function brings the temperature of the compartment down when activated a few hours prior to usage.</p>	 <p>Power saving mode: The power saving mode allows you to disable the refrigerator and keep the freezer working.</p>
 <p>LED interior lighting: is a more energy efficient and long lasting way of illuminating the interior of the appliance.</p>	 <p>Smeg's evolution towards more intelligent and eco-friendly models has led to the choice of Inverter technology, which significantly reduces consumption.</p>
 <p>Air plus: keeps food fresher for longer.</p>	 <p>Natural Plus Blu Light: This unique Natural Plus Blu Light system works with nature to increase the storage time of fruit and vegetables.</p>
 <p>No Frost: The No Frost and Frost free systems prevent ice from forming so that no defrosting is required.</p>	