

# CG90IANT9

Cooker size	90x60 cm
N. of cavities with energy label	1
Cavity heat source	ELECTRICITY
Hob type	Induction
Type of main oven	Thermo-ventilated
EAN code	8017709288716
Energy efficiency class	A



## Aesthetics

<b>Aesthetic</b>	Classica	<b>Display</b>	Touch
<b>Serie</b>	Concerto	<b>No. of controls</b>	2
<b>Colour</b>	Anthracite	<b>Serigraphy colour</b>	Silver
<b>Finishing</b>	Matt	<b>Handle</b>	Smeg round handle
<b>Design</b>	Standard	<b>Handle Colour</b>	Brushed stainless steel
<b>Door</b>	Full glass	<b>Glass type</b>	Black
<b>Hob colour</b>	Stainless steel	<b>Feet</b>	Black
<b>Command panel finish</b>	Enamelled metal	<b>Logo</b>	Assembled
<b>Control knobs</b>	Smeg Classic	<b>Logo position</b>	Facia below the oven
<b>Controls colour</b>	Stainless steel		

## Programme / Functions

**No. of cooking functions** 6

**Traditional cooking functions**



Static



Fan assisted



Turbo



Eco



Large grill



Fan assisted bottom

**Cleaning functions**



Vapor clean

## Hob options



Control lock	Yes	Limited Power	3000, 4500, 7400 W
Limited Power Consumption Mode	Yes	Consumption Mode in W	

## Hob technical features



Total no. of cook zones 4

Front left - Induction - single - 2.30 kW - Booster 3.00 kW - Ø 21.0 cm

Rear left - Induction - single - 1.30 kW - Booster 1.40 kW - Ø 18.0 cm

Rear right - Induction - giant - 2.30 kW - Booster 3.00 kW - Ø 21.0 cm

Front right - Induction - single - 1.30 kW - Booster 1.40 kW - Ø 18.0 cm

No. of cooking zones with Booster	4	Minimum pan diameter indication	Yes
Automatic switch off when overheat	Yes	Selected zone indicator	Yes
Automatic pan detection	Yes		

## Main Oven Technical Features



No. of lights	1	Removable inner door	Yes
Fan number	1	Total no. of door glasses	3
Net volume of the cavity	115 l	No. of thermo-reflective door glasses	1
Gross volume, 1st cavity	129 l	Safety Thermostat	Yes
Cavity material	Ever Clean enamel	Cooling system	Tangential
No. of shelves	5	Usable cavity space dimensions (HxWxD)	371x724x418 mm
Type of shelves	Metal racks	Temperature control	Electro-mechanical
Light type	Halogen	Lower heating element power	1700 W
Light Power	40 W	Upper heating element - Power	1200 W
Cooking time setting	Start and Stop	Grill element	1700 W
Light when oven door is open	Yes	Large grill - Power	2900 W
Door opening	Flap down	Circular heating element - Power	2000 W
Removable door	Yes	Grill type	Electric
Full glass inner door	Yes		

## Options Main Oven

Timer	Yes	Minimum Temperature	50 °C
End of cooking acoustic alarm	Yes	Maximum temperature	260 °C

## Accessories included for Main Oven & Hob

Rack with back and side stop	1	Grill mesh	1
40mm deep tray	1		

## Electrical Connection

Electrical connection rating	10600 W	Type of electric cable installed	Yes, Single phase
Current	46 A	Additional connection modalities	Yes, Double and Three Phase
Voltage	220-240 V	Frequency	50/60 Hz
Voltage 2 (V)	380-415 V	Terminal block	5 poles

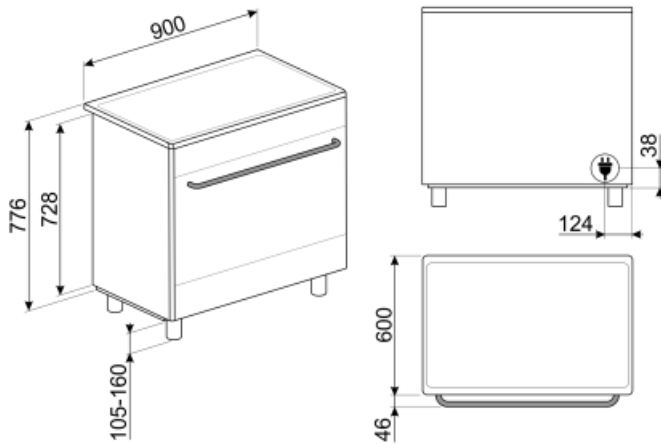

## Not included accessories

### AIRFRY9

Air fryer rack AIRFRY . Ideal for recreating traditional frying in the oven, but with fewer calories and less fat. It allows you to cook quickly and simply dishes such as French fries, fried vegetables and fish, ensuring perfect browning and crispiness.



### GTP

Partially extractable telescopic guides (1 level), suitable for traditional ovens. Made in stainless steel, they guarantee stability and facilitate the smooth extraction of the trays.



### PPR9

Refractory pizza stone without handles. Squared shaped stone: L64xH2,3xP37,5 cm Suitable also for gas ovens, to be put on the griddle.



### BBQ9



### KIT90X9-1

Splashback, stainless steel, 90cm, for Concerto cookers with single MF or gas oven

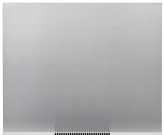

### KITPDQ

Height reduction feet (850mm), stainless steel, for Concerto cookers (850-881mm)



### PALPZ

Pizza shovel with folding handle. Dimensions L31.5 x H32.5 cm. Easy and convenient to use and store. Perfect for serving pizza, bread and savory pastries in a safe and professional way.



### SFLK1

Child lock



### PRTX

Refractory pizza stone with handles. D=35cm Not suitable for microwave ovens. Suitable for gas ovens, to be put on the griddle.



### KIT600SNL-9

Cover strip for hob back side, depth 60mm, suitable for 90cm single oven Concerto cookers



### KIT90N9

Splashback black , 90 cm, suitable for BU & BM cookers



### KITH95

Height extension feet (950mm), stainless steel, suitable for Concerto cookers (911-966mm)



### SCRP

Non-scratch hob scraper - suitable for induction and ceramic hobs



### GTT



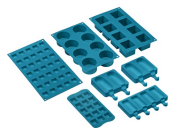













Totally extractable telescopic guides (1 level), suitable for traditional ovens. Made in stainless steel, they guarantee stability and facilitate the smooth extraction of the trays.









### SMOLD

Set of 7 silicone moulds for ice creams, ice lollies, pralines, ice cubes or to portion food. Usable from -60°C to +230°C

## Symbols glossary (TT)

 <p><b>Power booster:</b> option allows the zone to work at full power when very intense cooking is necessary.</p>	 <p><b>Child lock:</b> some models are fitted with a device to lock the programme/cycle so it cannot be accidentally changed.</p>
 <p><b>Air cooling system:</b> to ensure a safe surface temperatures.</p>	 <p><b>Triple glazed doors:</b> Number of glazed doors.</p>
 <p><b>ECO-logic:</b> option allows you to restrict the power limit of the appliance real energy saving.</p>	 <p><b>A:</b> Product drying performance, measured from A+++ to D / G depending on the product family</p>
 <p><b>Ever Clean Enamel:</b> Ever Clean enamel is applied electrostatically, corner to corner and edge to edge to prevent cracking or cracks over time. It is a particular pyrolytic enamel, resistant to acids which, in addition to being pleasantly bright, promotes greater cleaning of the oven walls, thanks to its lower porosity. It is baked at over 850 ° C and slowly polymerized at a scientifically determined rate to ensure uniform depth and strength Ever Clean enamel creates an impeccable finish both on the inside of the oven and on the trays, making the surfaces of the oven incredibly easy to maintain over time as it reduces the adhesion of fat during cooking</p>	 <p><b>Fan assisted base:</b> the mix of fan and lower heating element alone allows to finish cooking foods already cooked on the surface but not internally more quickly. This system is recommended to finish cooking foods that are already well cooked on the surface, but not internally, which therefore require a moderate higher heat. Ideal for any type of food.</p>
 <p><b>Fan assisted:</b> Intense and homogeneous traditional cooking, also suitable for complex recipes. The fan is active and the heat comes from below and from above at the same time. Ventilated cooking ensures a faster and more homogeneous result, leaving fragrant foods outside and moister inside. Ideal for baked pasta, biscuits, roasts and cobblers.</p>	 <p><b>Static:</b> Traditional cooking suitable for the preparation of one dish at a time. The fan is not active and the heat comes from below and from above at the same time. Static cooking is slower and more delicate, ideal in order to get well cooked and dry dishes even inside. Ideal for cooking all types of roasts, fatty meats, bread, filled cakes.</p>
 <p><b>ECO:</b> low energy consumption cooking: this function is particularly suitable for cooking on a single shelf with low energy consumption. It is recommended for all types of food except those that can generate a lot of moisture (for example vegetables). To achieve maximum energy savings and reduce time, it is recommended to put the food in the oven without preheating the cooking compartment</p>	 <p><b>Grill:</b> Very intense heat coming only from above from a double heating element. The fan is not active. Provides excellent grilling and gratinating results. Used at the end of cooking, it gives a uniform browning to dishes.</p>
 <p><b>Turbo:</b> the heat comes from 3 directions: above, below and from the back of the oven The fan is active. It allows quick cooking, even on several shelves without mixing the aromas. Ideal for large volumes or foods that require intense cooking.</p>	 <p><b>Giant zone:</b> The giant zone offers extra space and flexibility.</p>
 <p><b>Overheat protection:</b> The safety system that automatically turns off the hob in case of overheating of the control unit.</p>	 <p><b>Induction:</b> The work of these hobs is based on the principle of electromagnetic induction. The heat is generated directly in the bottom of the pan during its contact with the hob.</p>

- |  |  |
|--|--|
|  <p>All glass inner door: All glass inner door, a single flat surface which is simple to keep clean.</p> |  <p>The inner door glass: can be removed with a few quick movements for cleaning.</p>   |
|  <p>Side lights: Two opposing side lights increase visibility inside the oven.</p>                       |  <p>The oven cavity has 5 different cooking levels.</p>                                 |
|  <p>Vapor Clean: a simple cleaning function using steam to loosen deposits in the oven cavity.</p>       |  <p>The capacity indicates the amount of usable space in the oven cavity in litres.</p> |